

Design And Transient Thermal Analysis Of Few Welding Using Conical Tool

¹Mr. Vodnala Veda Prakash, ²Mr. Bachewal Venugopal, ³Mr. S. Suresh

^{1,2,3}Assistant Professor

Department of Mechanical Engineering

Kshatriya College of Engineering

ABSTRACT

Friction Stir Welding (FSW), invented by Wayne Thomas at TWI Ltd in 1991 overcomes many of the problems associated with traditional joining techniques. FSW is a solid-state process which produces welds of high quality in difficult-to-weld materials such as aluminium, and is fast becoming the process of choice for manufacturing lightweight transport structures such as boats, trains and aeroplanes. Aluminium alloys are lightweight materials relatively used in automotive industries. In FSW, the welding tool motion induces frictional heating and severe plastic deformation and metal joining process is done in solid state results, which results in defect free welds with good mechanical properties in aluminium alloy 5083. A study was made of weldability of 4mm-thick Aluminium alloy 5083 plates using friction stir welding. The plan of experiments was prepared based on abilities of universal milling machine. The welding parameters in Friction Stir Welding (FSW) play a principle role in quality of the weld. The tool rotational speeds of 900r/min, 1120r/min, 1400r/min and 1800r/min, the welding speed of 40mm/min were taken. The butt-joint types of aluminium plates were welded and then mechanical and thermal properties were to be analyzed. The microstructures of various regions were observed and analyzed by means of optical and scanning electron microscope. The tensile properties and micro-hardness were evaluated for the welded joint. The speeds are 900rpm, 1120 rpm, 1400rpm and 1800rpm. The temperatures taken for thermal analysis were also varying with the tool rotational speeds respectively. The effects of different tool pin profiles on the friction stir welding will also be considered for analysis. Different tool pin profiles are circular, tapered circular. As the joining process in friction stir welding is done below the melting point of base metal, it can be considered as the most significant development in metal joining world. It is essential to measure the amount of temperature distribution during friction stir welding as it had direct influence over the mechanical properties of the weld zone and heat affected zone. However, it is difficult to measure temperature in the weld zone due to the plastic deformation produced nonconsumable rotating tool. In this research proposal, development in the analysis of heat generation and temperature distribution are addressed.

Keywords: Friction stir welding, tool pin profile, FSW parameters, mechanical properties, microstructure analysis, 5083 Aluminium alloy, Tool geometry, SEM analysis, temperature distribution, thermal analysis.

INTRODUCTION

Aluminum is the most prominent material to meet the challenges of future automotive regarding high strength to weight ratio, corrosion resistance, emissions, safety and sustainability. The welding of aluminum and its alloy is difficult by fusion welding and resistance spot welding due to high thermal and electrical conductivity. Friction stir welding (FSW) is a solid state welding process and it is considered to be the further most improvement in metal joining technique in the last two decades. FSW was invented by The Welding Institute (TWI) UK, and it was initially applied to join aluminum alloys. However, the extended application of this welding process in industry still require accurate knowledge of this joining mechanism, and the metallurgical and mechanical properties changes it induces in the base materials. Actually the effectiveness of the obtained joint is strongly dependent on several operating parameters. First of all, the geometry parameters of the tool, such as tool pin height, shape of the profile and shoulder surface of the head, have greater influence on both metal flow and heat generation due to friction forces. Secondly, the process factors such as tool rotational speed, welding speed, and tool tilt angle etc., to be selected in order to improve nugget integrity that results in a proper microstructure and eventually in good tensile strength fatigue strength and

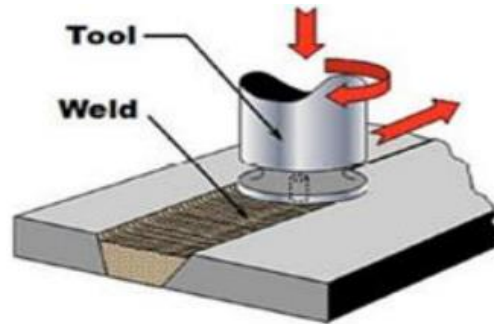

Fig .1 The Fsw process

ductility of the joint.

SURVEY OF WORK DONE IN RESEARCH: Senkara et al. and by Miles et al.[1&2] this study evolves that mechanical properties of the welds formed from AA5XXX alloys depend mostly on the grain size and the dislocation density due to the phenomena of plastic deformation and recrystallization happening during the FSW process. Kulekci et al.[3] the effects of the tool pin diameter and tool rotation speed at a unvarying traverse speed, were investigated on fatigue properties of friction stir overlap welded Alloy Al 5754. Song and Kovacevic et al.[4] had modeled the heat transfer in FSW using the finite difference method. Few papers were also directly dealt with the modeling of the thermomechanical stresses in FSW.

Gan et al., 2008,[5] Recent work has shown abnormal grain growth (AGG) for heat treated AA5083-H18 subsequent FSW. Thermo-mechanical modeling for friction stir butt welding (FSBW) process was presented in this work for AA5083-H18 using the CFD FVM code, STAR-CCM[®] (CD - Adapco, 2007). Temperature dependent material properties were implemented via a user subroutine. The process, consisting of plunging, short dwell, long linear welding and retracting steps, was simplified as a steady state process wherein the process achieves an equilibrium operating temperature in a fairly short time (Badarinarayan, 2007).

Siva kumar et al.[6] The fundamental principles of FSW are described, as well as metal flow and thermal history, before discussing how process parameters affect the weld microstructure and the likelihood of defects. Finally, the range of mechanical properties that can be achieved is discussed. Heat is created primarily by viscous dissipation in the workpiece material close to the tool, driven by high shear stresses at the tool/workpiece interface. The temperature and normal contact stresses vary broadly over the tool. As discussed above, local melting may occur as peak temperatures reach the solidus temperature. Process modelling using CFD has been used to explore the sensitivities of the heat generation, tool forces and size of deformation zone as a function of tool design and process conditions.

ATHARIFAR and CAVALIER et al. [7] discussed the effect of tool rotation and travel speed on the microstructure and mechanical properties of FSWed aluminum AA 6056 joints and optimized the procedure parameters.

Schmidt and Hattel (2005) [8]and Zhang (2007a, 2008) to examine the mechanism of controlling of welding parameters. Numerical methods are necessary, and reputable thermo-mechanical models to forecast the material deformations and the temperature distributions.

M. M. El-Sayed et al. [9] used a 3D transient heat transfer model was developed by ABAQUS software. This paper is to study the temperature distribution during friction stir welding process at different rotational speeds. Moreover, AA 5083-O plates were joined by FSW method. The joints were friction stir welded at a constant travel speed 50 mm/min and two rotational speed values; 400 rpm and 630 rpm using two types of tools; cylindrical threaded pin and tapered smooth one. The maximum crest temperature obtained was at higher rotational speed using the threaded tool pin profile. Moreover, the threaded tool gives superior mechanical properties than the tapered one at lower rotational speed.

Tomotake Hirata et al. [10] In his study, the effect of FSW process parameters on the grain size of the stir zone and the formability of FS-welded 5083 Al alloy was examined. The microstructures of the stir zones consisted of fine equiaxed grains at a variety of FSW circumstances in FS-welded 5083 Al alloy. The tensile strength under each FSW condition was almost the same. However the formability in FS-welded 5083 Al alloy was improved by decreasing the friction heat flow.

C.M. Chen et al. [11] used a three-dimensional model based on finite element analysis was used to study the thermal history and thermo-mechanical process in the butt-welding of aluminum alloy 6061-T6. The model incorporates the mechanical reaction of the tool and thermo-mechanical process of the welded material. The heat source incorporated in the model involves the friction between the material and the probe and the shoulder. The forecast and measurement explain that the maximum temperature gradients in longitudinal and lateral directions are situated just beyond the shoulder edge.

Bendzsak et al. [12] used the finite volume method to compute the flow around the tool. Arrow plots and particle tracks were used to visualise the flow field, which was superior in size than that observed experimentally. The flow indicated by the model was divided into two regions. Near the shoulder, it was largely rotational while further down it appeared to extrude around both sides of the tool. Spirals were observed between these two regions and it was postulated that these could be the reason of weld defects. **Leitao et al.** [13] analyzed the tensile behaviour of FSW of similar and dissimilar AA5182-H111 and AA6016-T4 joints. **Palanivel et al.** [14] studied the effect of tool rotational speed and pin profile on microstructure and tensile strength of dissimilar friction stir welded AA5083-H111 and AA6351-T6 aluminum alloys.

Peel et al. [15] studied the effect of tool rotational speed and traverse speed on the thermal history and weld properties of AA5083 and AA6082-T6 joints.

Leala et al. [16] investigated the influence of tool geometry on material flow for friction stir welded AA5182-H111 and AA6016-T4 Al alloys.

P Satish Kumar et al. [17] in this current research work, the effect of tool rotational speed on micro structural and mechanical properties of Friction stir welded 5083 Aluminium alloy was studied. The welding parameters, particularly tool rotational speed plays a main role in deciding the weld quality. It is observed that superior mechanical properties are obtained at a rotation speed of 710 rpm, 40 mm/min welding speed with taper with threaded profile

E. Fereiduni et al. [18] used Al-5083 and steel alloy St-12 alloy sheets with the thicknesses of 3 and 1 mm as a material for friction stir welding. Temperature variation at the joint interface was calculated. Rotational speeds of 900 and 1100 rpm were used with the dwell times of 5, 7, 10, 12 and 15 seconds to weld material. Then tensile and shear test are conceded out on three specimens for each processing condition and the average values were recorded. They found that when the dwell time increases joint strength increases up to certain limit and then start declining.

Raza Moshwan et al. [19] studied Effect of tool rotational speed on force generation, microstructure and mechanical properties of friction stir welded Al-Mg-Cr-Mn (AA 5052-O) alloy. Base metal chosen was 100×50 ×3 mm and hardened mild steel as tool material with rotational speeds of 800, 1000, 1500, 2000, and 3000 while the traverse speed was constant at 120 mm/min. Standard metallographic techniques such as Scanning electron microscope, energy dispersive spectroscopy (EDS) and field emission scanning was used for studying microstructure, mechanical tests such as tensile tests and hardness measurements conducted.

Jawdat A. and Al-Jarrah et al. [20] Worked for optimization of FSW Parameters for Joining Aluminum Alloys Using RSM. He taken aluminum alloy sheets with thicknesses of 4, 5, 6, 7 and 8 mm were Butt jointed. High carbon steel used as tool material with flat cylindrical shoulder diameters of 18, 21, 24, 27 and 30 mm. rotational speed range used were 400, 700, 1000, 1300 and 1600 rpm. And welding speed range used 0.5, 1.0, 1.5, 2.0 and 2.5 mm/sec. it was bring into being that a general result for a plate thickness of 6 mm, This experiment results defect free joints.

Ankur S Vasava et al. [21] The dominating heat generation mechanism is influenced by the weld parameters, thermal conductivities of the work piece, pin tool and backing anvil, and the weld tool geometry and also depend on the contact surroundings between the two surfaces. The weld tool geometric features of both the pin and the shoulder influence whether the two surfaces slide, stick, or alternate between the two modes.

Mostafa M et. al., [22] in the near investigation, a 3D transient heat transfer model was developed to simulate the thermal distribution of aluminum alloy 5083-O friction stir welded by using Abaqus software. A 6 mm AA5083-O plates were friction stir welded at different conditions; two tools with tapered smooth and cylindrical threaded pin profiles, and 50, 100, 160 mm/min welding speeds at a constant rotational speed of 400 rpm. The temperature was measured using an infrared thermal image camera during the welding process for every joint operation condition. The calculated temperature by IR camera was compared with temperatures obtained using the Abaqus. The defect free welded joints were obtained at 50, 100, 160 mm/min welding speeds using a threaded tool pin profile. The tensile strength values obtained by using a threaded tool pin profile at all welding speeds were enhanced than those obtained by using a tapered tool pin profile where the best one was at 50 mm/min welding speed. The peak temperature obtained from simulation was just about near the measured one. Therefore, this heat transfer model can be used to guess the temperature

distribution during the FSW process. The peak temperature of the welded joints decreases by increasing the welding

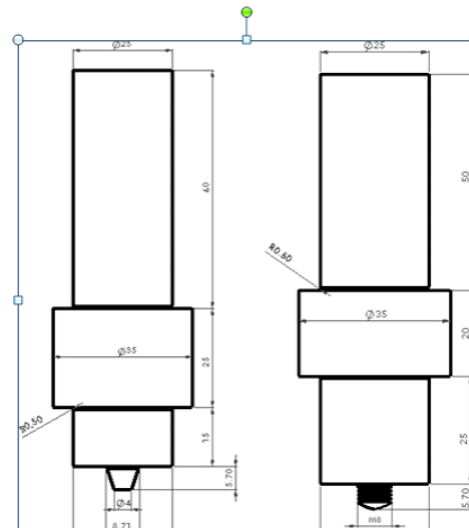

speed for the same tool pin profile and rotational speed.

Pew et al.[23] developed a torque-based weld power model to guess the heat input obtainable for a wide range of parameters in any Al alloy during FSW. Because the weld power is a role of torque, the torques measured at various welding parameters in three types of Al alloys were empirically interrelated with the input variables. These empirical models predict the weld power with an accuracy of 93%, ensuing in the calculation of accurate heat input (the weld power divided by travel speed).

H.J. Zhang et al. [24] in this study, 6061 aluminum alloy was friction stir welded at high-rotation speeds ranging from 3000 to 7000 rpm at a fixed welding speed of 50 mm/min, and the effects of rotation speed on the nugget zone macro and microstructures were investigated in detail in order to illuminate the process features. Temperature measurements during HRS-FSW indicated that the peak temperature did not increase constantly with rotation speed. The temperature during HRS-FSW was irregularly distributed. For each rotation speed, the measured peak temperature was higher on the AS than on the RS. As the rotation speed increased above 5000 rpm, the reduction in peak temperature can be observed due to the decrease in shear stress of the plastic material around the tool. At the rotation speed of 5000 rpm, the weld material experienced weaker thermal effect and higher-strain-rate plastic deformation.

Sxefika and Fatih et al. [25] studied the effect of process parameters like tool rotational speed and feed rate (welding speed) on percentage of elongation, ultimate tensile strength (UTS) and hardness for a welded joint of AA 5083-H111 aluminum alloy. In their work, welding tool with a triangular pin was used. Based on the experimental results, it was concluded that the UTS and percentage of elongation of the welded joint were bring into being to be decreased with increase of tool rotational speed.

Mohammad et al. [26] in this FEM approach was taken to reveal the effect of tool geometry on welding characteristics like force, flow of metal and heat-affected zone in welding of AA5083 aluminum alloy. They conducted experiments at different levels of pin shoulder diameters and results were collected. Artificial neural network models were also developed to correlate the results with FEM and experimental outcomes. Optimum process parameters were acknowledged using these methods.

Trimble et al. [27] have developed FEM models to study and predict temperature and tool forces. The predicted values were correlated with the experimental results. The FEM models were used to optimize pin size to improve efficiency of the welding.

K. Venkata Rao et al. [28] in this study, effect of tool rotational speed, pin diameter and tilt angle was considered on the tool vibration, UTS and welding forces in the X, Y and Z directions. With the help of DEFORM 3D software, a numerical simulation model was developed to forecast the welding characteristics.

E. Ahmadi et al. [29] used aluminium 5083-H112 plates for friction stir welding. The finite element analysis of variation of temperature in FSW of two similar simplifying geometry plates is performed with the ANSYS software. A good agreement between the numerical and experimental results is obtained.

I.Ajit kumar et al.[30] in his research work FEA is performed for friction stir welding of Aluminium and copper. The welds were formed by varying the process parameters like, the rotational speed at 900rpm, and welding speed varied between 60 and 80 mm/min. Then the thermal analysis was performed.

Leonardo. N et al. [36] used FSWelds of AA5052-H32 on plates of 3mm obtained with different tool shoulder diameters were analyzed. The effect of the shoulder diameter and the resulting heat liberated were linked with different characteristics of the weld joints.

S. Sattari et al. [31] in this approach friction stir welded (FSW), 0.8mm in thickness 5083 aluminium sheets have been studied. A special fixture, de-signed for ultra-thin sheets, and a simple cylindrical tool, was used. Tensile test and micro hardness test was investigated. All tested samples were defect free. Temperature measurements during welding indicate that 4300 C to 5100C was the greatest temperature range for defect free joints. Increase in speed rate results additional heat input. In this case tool rotation speed was more effective than feed rate. Defect free welds achieved between 4300C and 5100 C.

Armansyah et al. [32] used transient thermal finite element analyses are performed to model the temperatures distribution and its quantities in weld-zones with respect to process variables such as rotational speed and traveling speed during welding. Commercially available software Altair HyperWork was used to model three-dimensional tool pin-shoulder vs. workpieces and to simulate the friction stir process.

Perumalla Janaki Ramulu et.al. [33] In this study aims to look at the temperature evolution during friction stir welding of Aluminum 6061-T6 under different process parameters like plunge depth; tool rotation speed; and welding speed with three different tool shoulder diameters. Thermocouples were inserted in the pre-holed work-pieces. Experimental results show that by rising the plunge depth, tool rotation speed, the maximum temperature increased, whereas it was contrary for welding speed.

Saurabh Kumar Gupta et.al.[34] In this study, observed the effect of FSW process parameters such as tool rotational speed and welding speed on temperature distribution to joining of different AA5083-O and AA6063-T6 aluminum alloys. For study the effect of process parameters, nine experiments based on full factorial design were performed by varying the rotational speed and welding speed and later analysis of variance (ANOVA) was conceded out to find out the significance of process parameters. For each experiment observed that peak temperature at retreating side was poorer as compared to advancing side. Peak temperature decreases with decreasing the tool rotational speed but vice versa with welding speed.

H.J. Zhang et al. [24] in this study, 6061 aluminum alloy was friction stir welded at high-rotation speeds ranging from 3000 to 7000 rpm at a fixed welding speed of 50 mm/min, and the effects of rotation speed on the nugget zone macro and microstructures were investigated in detail in order to illuminate the process features. Temperature measurements during HRS-FSW indicated that the peak temperature did not increase constantly with rotation speed. The temperature during HRS-FSW was irregularly distributed. For each rotation speed, the measured peak temperature was higher on the AS than on the RS. As the rotation speed increased above 5000 rpm, the reduction in peak temperature can be observed due to the decrease in shear stress of the plastic material around the tool. At the rotation speed of 5000 rpm, the weld material experienced weaker thermal effect and higher-strain-rate plastic deformation.

Sxefika and Fatih et al. [25] studied the effect of process parameters like tool rotational speed and feed rate (welding speed) on percentage of elongation, ultimate tensile strength (UTS) and hardness for a welded joint of AA 5083-H111 aluminum alloy. In their work, welding tool with a triangular pin was used. Based on the experimental results, it was concluded that the UTS and percentage of elongation of the welded joint were bring into being to be decreased with increase of tool rotational speed.

Mohammad et al. [26] in this FEM approach was taken to reveal the effect of tool geometry on welding characteristics like force, flow of metal and heat-affected zone in welding of AA5083 aluminum alloy. They conducted experiments at different levels of pin shoulder diameters and results were collected. Artificial neural network models were also developed to correlate the results with FEM and experimental outcomes. Optimum process parameters were acknowledged using these methods.

Trimble et al. [27] have developed FEM models to study and predict temperature and tool forces. The predicted values were correlated with the experimental results. The FEM models were used to optimize pin size to improve efficiency of the welding.

K. Venkata Rao et al. [28] in this study, effect of tool rotational speed, pin diameter and tilt angle was considered on the tool vibration, UTS and welding forces in the X, Y and Z directions. With the help of DEFORM 3D software, a numerical simulation model was developed to forecast the welding characteristics.

E. Ahmadi et al. [29] used aluminium 5083-H112 plates for friction stir welding. The finite element analysis of variation of temperature in FSW of two similar simplifying geometry plates is performed with the ANSYS software. A good agreement between the numerical and experimental results is obtained.

I.Ajit kumar et al.[30] in his research work FEA is performed for friction stir welding of Aluminium and copper. The welds were formed by varying the process parameters like, the rotational speed at 900rpm, and welding speed varied between 60 and 80 mm/min. Then the thermal analysis was performed.

Leonardo. N et al. [36] used FSWelds of AA5052-H32 on plates of 3mm obtained with different tool shoulder diameters were analyzed. The effect of the shoulder diameter and the resulting heat liberated were linked with different characteristics of the weld joints.

S. Sattari et al. [31] in this approach friction stir welded (FSW), 0.8mm in thickness 5083 aluminium sheets have been studied. A special fixture, de-signed for ultra-thin sheets, and a simple cylindrical tool, was used. Tensile test and micro hardness test was investigated. All tested samples were defect free. Temperature measurements during welding indicate that 4300 C to 5100C was the greatest temperature range for defect free joints. Increase in speed rate results additional heat input. In this case tool rotation speed was more effective than feed rate. Defect free welds achieved between 4300C and 5100 C.

Armansyah et al. [32] used transient thermal finite element analyses are performed to model the temperatures distribution and its quantities in weld-zones with respect to process variables such as rotational speed and traveling speed during welding. Commercially available software Altair HyperWork was used to model three-dimensional tool pin-shoulder vs. workpieces and to simulate the friction stir process.

Perumalla Janaki Ramulu et.al. [33] In this study aims to look at the temperature evolution during friction stir welding of Aluminum 6061-T6 under different process parameters like plunge depth; tool rotation speed; and welding speed with three different tool shoulder diameters. Thermocouples were inserted in the pre-holed work-pieces. Experimental results show that by rising the plunge depth, tool rotation speed, the maximum temperature increased, whereas it was contrary for welding speed.

Saurabh Kumar Gupta et.al.[34] In this study, observed the effect of FSW process parameters such as tool rotational speed and welding speed on temperature distribution to joining of different AA5083-O and AA6063-T6 aluminum alloys. For study the effect of process parameters, nine experiments based on full factorial design were performed by varying the rotational speed and welding speed and later analysis of variance (ANOVA) was conceded out to find out the significance of process parameters. For each experiment observed that peak temperature at retreating side was poorer

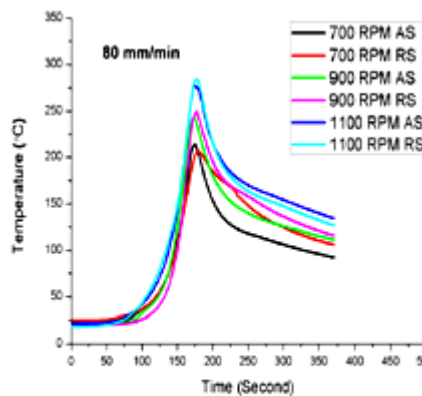
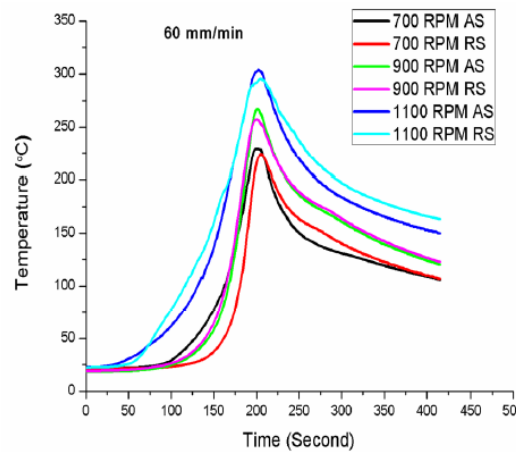
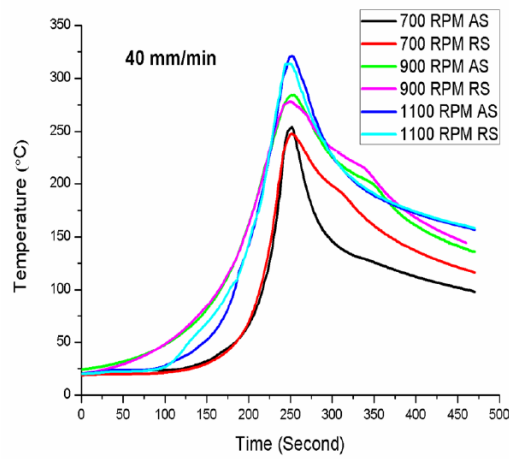

Temperature profile at (a) 40 mm/min (b) 60 mm/min (c) 80 mm/min

as compared to advancing side. Peak temperature decreases with decreasing the tool rotational speed but vice versa with welding speed.

MILANGOVA et al. [35] In this investigation, an attempt has been made to join the heat treatable (AA 6061) and non heat treatable (AA 5086) aluminium alloys by friction stir welding (FSW) process using three different tool pin profiles resembling straight cylindrical, taper cylindrical and threaded cylindrical. From this investigation it was founded that the use of threaded pin profile of tool contributes to Pasquale Cavaliere et. al. [36] In the present study the effect of processing parameters on tensile, fatigue and crack behavior of several aluminum alloys was described. The experimental data were engaged to make a database capable of developing a model useful for predicting mechanical performances of FSW joints. It was underlined the different weight of processing parameters on finishing performances of the welds.

Pasquale Cavaliere et. al. [36] In the present study the effect of processing parameters on tensile, fatigue and crack behavior of several aluminum alloys was described. The experimental data were engaged to make a database capable of developing a model useful for predicting mechanical performances of FSW joints. It was underlined the different weight of processing parameters on finishing performances of the welds.

R. Palanivel et.al. [37] This study making focus on the tensile behaviour of dissimilar joints of AA6351-T6 alloy to AA5083-H111 alloy produced by friction stir welding. Five different tool pin profiles, such as Straight Square (SS), Tapered Square (TS), Straight Hexagon (SH), Straight Octagon (SO) and Tapered Octagon (TO), with three different welding speeds (50 mm/min, 63 mm/min, 75 mm/min) have been utilized to weld the joints. Among the fifteen joints produced in this investigation, the joints produced using the straight square pin profiled tool at a welding speed of 63 mm/min showed the best tensile properties.

A. C. F. Silva et.al. [38] This paper presents an summary of temperature measurement methods applied to the FSW process. Three methods were evaluated in this work: thermocouples surrounded in the tool, thermocouples embedded in the workpiece and the tool-workpiece thermocouple (TWT) method. The results show that TWT is an exact and quick method suitable for feedback control of FSW.

Yuh J. Chao et.al. [39] An included experimental and numerical analysis is performed to study the heat transfer aspect of the friction welding process in a normal and a cold FSW weld. The temperature and heat flow in together the tool as tool steel and the workpiece as aluminum alloy 2195 were obtained.

P.Prasanna et.al. [40] In this paper, an effort has been made to study the effect of four different tool pin profiles on mechanical properties of AA 6061 aluminum alloy. Four dissimilar profiles have been utilized to fabricate the butt joints by keeping steady process parameters of tool rotational speed 1200RPM, welding speed 14mm/min and an axial force 7kN. Different heat treatment methods like annealing, normalizing and quenching have been applied on the joints and evaluation of the mechanical properties like tensile strength, percentage of elongation, hardness and microstructure in the friction stirring formation zone were evaluated. From the above made discussion, it was found that the hexagonal tool profile produces good tensile strength, percent of elongation in annealing and hardness in quenching process.

Amit Goyal et.al.[41] The present research work focuses on the comparative analysis of effect of tool pin profile and material position on leading and trailing side of the welding tool on weld quality of dissimilar AA5086 H32 and AA6061 T6 aluminum alloy joints fabricated using friction stir welding technique. Five different tool pin profiles viz. hexagonal (HX), Square (SQ), Threaded cylinder (TC), pentagonal (PT) and Straight cylindrical (SC), were used to fabricate joints by changing the position of material on advancing and retreating side of the tool. Five specimens were fabricated by keeping AA6061-T6 on advancing side of the tool for different profile welding tools and another five were fabricated by keeping AA5086-H32 on advancing side of the tool. The joints were inspected for visible defects like pin hole, surface cracks, tunnel defect, etc. and it was observed that FSW can be effectively employed to join dissimilar AA5086 H32 and AA6061 T6 aluminum alloy sheets. Out of the five profiles of the welding tools used in this study, square pin profile was observed as superior in requisites of producing sound quality joints.

Jaimin B. Patel et.al.[42] This paper presents the modelling of FSW for various tool-pin profiles along with simulation of peak temperature induced in plate material and flow stresses generated in the same for friction stir welding of AA6061. The modelling has been carried out by using the FEA software. In present work the three dimensional nonlinear thermal numerical simulations are conducted using Hyper Weld software module for FSW butt joints of AA6061 alloy. Friction stir welding simulation is performed for various tool pin profile at constant 600rpm speed and thermal distribution is analyzed. It was observed that hexagonal pin profile provides better flow of material particles with slightest resistance amongst all other pin profiles.

K.D.Bhatt et. al. [43] Friction stir welding (FSW) of AA6061- T6 aluminum alloy has been attempted to beat limitations of fusion welding of the same. A software based study to find effect of tool dimensions on the peak temperatures generation during FSW for the said aluminum alloy was carried out to discover the capabilities of the same and supply basis for extra research work related to the different aluminum alloys. It is observed from the distribution results that peak temperature increases by increasing the size of the FSW tool and distribution of viscosity varies accordingly. As the temperature history is simulated using HyperWorks9.0, the results for temperatures can be validated by experimentally measuring the same using a sophisticated measuring device capable of memorizing the output data in various forms.

S Verma et.al.[44] the aim of present study was to experimentally discover the distribution of temperature during the friction stirred butt joint of aluminum 6082 plates. Eight L shaped thermocouples are placed at equally distance from the center line to measure the resulting temperature; four thermocouples on advance side (AS) and four on retreating side (RS). The experiment is conducted at constant rotational speed and feed rate and with varying tool tilt angle and dwell time. It was observed that the temperature on advancing side is on higher side as compared to retreating side.

Santhosh N et.al.[45] The present work involves physical understanding of friction stir weld joint creation and influence of weld process parameters from the united complementary efforts of experimental examination and numerical

modeling. The thermo-mechanical modeling of friction stir welding process was carried out by using general use Finite Element Analysis (FEA) simulation tool 'Altair Hyperwork's to evaluate the significant physical aspects of FSW. Further, the simulation model was tested with experimental results, the results of the simulation were found to be in good agreement with that of experimental results, validating the model. It was observed from the analysis that for the constant tool traverse rate and increasing tool rotation speeds the peak temperatures during welding were increased foremost to lower flow stresses. On the other hand as the tool traverse rate increases with the tool rotation speed constant, the total heat input decreases which leads to decrease in temperature, increasing the flow stress required for continuous deformation of material for joint formation

Elhadj Raouache et.al., [46] In this paper, a three dimensional finite element was developed to study the transient thermal analysis of friction stir welding (FSW) for different tool geometries and dissimilar process parameters. The objective of this work was to investigate and analyze the temperature distribution of tool and work piece during operation using COMSOL MULTIPHYSICS. This study paying attention of the temperature variation reached during the progress of the welding material during the welding. The effect of the geometry of pin, as well as the speed of rotation of the tool, the penetration effort and the forward speed has studied. Tool probe geometry was very much answerable for deciding the weld quality. The maximum value of the temperature obtained near the weld increases as the tool holding time and rotational speed were increased.

R Vaira Vignesh, [47] In this paper, transient temperature distribution during FSW of aluminum alloy AA6061-T6 was simulated using finite element modelling. The model was used to predict the peak temperature. And it was also used to analyse the thermal history during FSW. The effect of process parameters namely tool rotation speed, tool traverse speed (welding speed), shoulder diameter and pin diameter of tool on the temperature distribution was investigated by means of two level factorial design. The model results were validated using the experimental results from the published literature. It was found that peak temperature was directly proportional to tool rotation speed and shoulder diameter and inversely proportional to tool traverse speed.

R. Padmanaban et.al., [48] In this present study CFD based model for the heat transfer and material flow during dissimilar friction stir welding of AA2024-AA7075 was developed. The temperature distribution was found to be asymmetric and the maximum temperature reached is between 80 to 90% of the liquidus temperature of material welded. The temperature distribution in FSW was affected by both TRS and WS. Specially increasing of TRS, increases peak temperature during FSW, at the same time as peak temperature decreases with increase in WS.

M Song and R Kovacevic et.al., [49] A mathematical model was described the detailed three-dimensional transient heat transfer process in friction stir welding (FSW). This work is together theoretical and experimental. An explicit central deferential plan was used in solving the control equations, the heat transfer phenomena during the tool piercing, the welding and the tool-removing periods that were studied dynamically. The heat input from the tool shoulder was modeled as a frictional heat and the heat from the tool pin was modeled as an unvarying volumetric heat generated by the plastic deformation near the pin. The temperature variation throughout the welding was also calculated to validate the calculated results. The calculated results were in good agreement with the experimental data.

M. Moradijoz et.al., [50] In this study, primarily using the Taguchi approach a design of experiment method to place the optimal process parameters is investigated. It was shown that with increasing the shoulder diameter, the tensile strength increases and with increasing the tool rotational speed the tensile strength decreases. The traverse speed has less effect. In addition temperature distribution was investigated experimentally. Outcomes were compared with the software based on finite element method, analytical method, and analytical-empirical method. Temperature distribution was achieved experimentally. Results were compared with the software based on finite element method (FEM), analytical, and analytical-empirical. The analytical-empirical Rosenthal's model indicated good concurrence with the experimental data.

Mr. P H Shah et.al., [51] In this paper the temperature distributions in the workpiece Al 7075 T651 were resolute experimentally during the FSW process. Dissimilar tool shoulder diameters were used to virtually explore the thermal histories in the workpiece during the FSW process of Al 7075 T651 joints. The transient temperatures during FSW were calculated with different thermocouple layouts. It was observed that the temperatures on the advancing side of the weld were little bit higher than that of the retreating side of the weld. Though it is extremely difficult to measure the temperatures at the weld line, an attempt has been made to determine the temperatures in the region of the rim of the tool shoulder. From the study it can be concluded that the appropriate temperature for a defect free friction stir weld of Al 7075 T651 can be contained by the range of 375 - 4200C. The joints fabricated with 20mm shoulder diameter yield maximum joint efficiency.

Arun Kumar Kadian et.al., [52] In this present work two different tool geometries has been considered to study the material flow patterns of the welding process. A 3-D CFD analysis was performed with appropriate boundary circumstances to study the character of material flow actions of FSW process. The parameters used for the analysis of welding process also varied one by one for both the cases to attain a good assessment on the effect of tool geometry on the material flow. It was observed that in FSW tool geometries has significant effect on material flow behavior.

V. Patel Chandresh et al., [53] resulted research usually lies on characteristics of FSW tool pin's profile on FSW joint. In this work was carried out using dissimilar tool pin profile like taper cylindrical, square, taper hexagonal, and threaded cylindrical. Test specimen has been prepared from acquire results and various tests (tensile and bending test) will be carried out to show its optimal joints. On the basis of these results and parameters used all over experiment the effect of tool pin profile will be understood

Kuber Singh Patel et al., [54] In this study analysis of effects of tool geometries on thermal and mechanical behaviour during welds of aluminium alloy on friction stir welding was passed out. In this work two tool geometries were taken, the first one straight cylindrical tool geometry; second one tapered threaded cylindrical tool geometry. Analysis was successfully finished and obtained satisfactory results, optimal results for SS316 tool material for both geometries were 75mm/min and 635 rpm were obtained which gives utmost temperature and acceptable von-mises stress.

Ashok Kumar et al. [55] discussed on the different parameter of the FSW. In this paper analyzed the joint characteristics of similar and dissimilar materials used in fabrication industries which are complicated to join by other technique. The analysis was completed with the help of ANSYS software computationally & same was experimentally confirmed.

S. Ravikumar et al [56] analyzed the tensile strength and yield strength of dissimilar friction stir welded aluminium alloys 7075 and 6061 through examining the micrographs from the scanning electron microscope and EDAX method using three different types of tool profiles. The results indicated that the joints produced from threaded taper cylindrical tool at tool rotational speed of 900 rpm and welding speed of 100 mm/min has improved strength due to the thorough metallic materials mixing.

Pradeep and Muthukumar et al., [57] used tool having a conical pin of 0.4 mm clearance. Process parameters were optimized by using the Taguchi technique. Experiments designed based on three process parameters, tool rotational speed, tool tilt angle and travel speed. Tensile strength was used as response. A conical shorter pin tool was enhanced strength of weld at a lower travel speed, and it helps in the reduction of tool wear, by lesser usage of the tool material.

A. Chandrashekar et al., [58] In this research work, an attempt has been made to investigate the connection between FSW variables mainly tool profile, rotating speed, welding speed and the mechanical properties (tensile strength, yield strength, percentage elongation, and microhardness) of friction stir welded aluminum alloy 5083 joints. From the experimental details, it can be assessed that the joint produced by using Triflute profile tool has put in superior mechanical and structural properties as compared to Tapered unthreaded & Threaded tool for 1000rpm. For aluminium 5083, at 1000 rpm, tapered unthreaded tool profile was bring into being to be the optimum tool, at 600 rpm, tapered threaded tool profile was found to be the optimum tool, at 1000 rpm, Triflute tool profile was found to be the optimum tool. It has been observed that the variation in tensile strength occurs for different tool profiles. The change in percentage in the tensile strength was found to be 48.62 % for Tapered unthreaded tool as the welding speed increases from 800 to 1000rpm, 65.77% for Tapered threaded and 33.36 % for Triflute tool speed increases from 600 to 1000rpm. The decrease in tensile strength has been found for tapered unthreaded tool profile and it has been increased for triflute tool profile in contrast with other profiles.

T.

U. **Sahu and Pal** [59] were carried out experiments by using Taguchi's L18 factorial design of experiment. Grey rational analysis was used for optimizing process parameters. Percentage effect of individual process parameter on the weld quality was measured. They used AM20 Magnesium alloy to form square butt joint. Process parameters were used tool rotation speed, welding speed, and shoulder diameter and plunge depth. Subsequent to welding tensile tests were conducted to find out ultimate tensile strength and yield strength. They found optimized process parameters were plunge depth at 0.12 mm, welding speed at 98 mm/min, rotational speed at 1100 rev/min and shoulder diameter at 24 mm

E. Fereiduniet al. [60] used Al-5083 and steel alloy St-12 alloy sheets with the thicknesses of 3 and 1 mm as a material for friction stir welding. Temperature variation at the joint interface was measured. Rotational speeds of 900 and 1100 rpm were used with the dwell times of 5, 7, 10, 12 and 15 seconds to weld material. Then tensile and shear test are carried out on three specimens for each handling out condition and the average values were recorded. They found that as dwell time increases joint strength increases up to convinced limit and then start declining

PankajNeoget al. [61] was conducted welding on 6.35 mm thick plate of AA7075-T6 alloy using friction stir welding technique. He used square butt joint in the experiments as it found better result. Process parameters were rotational speed, welding speed and axial load, output variable as tensile strength. Positive relationship was there between the load and tensile strength. If axial load increases tensile strength also increases.

Sadeesh P et al. [62] used material i.e. 5mm thick plate of AA 2024-T4 (Al-Cu alloy) and AA 6061-T4 (Al-Mg-Si alloy). The plates were cut into rectangular shapes of 100 × 50 mm and the welding had been carried out. Tool used in

his study was AISI H13 tool steel, which has high thermal fatigue resistance. The dissimilar shape pin profiles used in this work were cylindrical pin, threaded pin, tapered pin, squared pin and stepped pin. The process parameters used were tool shape, rotational speed, traverse speed, tilting angle. AA2024 were placed on the advancing side due to its higher mechanical strength and the tool pin was positioned at center of joint line. Micro hardness was carried out at a load of 100 gf with dwell time of 10 seconds and distance of 0.25 mm gap across the welded joint. It was found by studying literature that the rotational speed of 710 rpm, traverse speed of 28 mm/min and D/d ratio of 3, for cylindrical pin, were the majority efficient.

Raza Moshwanet et al. [63] used 3 mm thick AA 5052-O aluminum alloy plates in his experiment. Specimens were welded using constant tool traverse speed of 120 mm/min and by altering rotating speeds from 800 to 3000 rpm. Then welded joints studied for its appearances, micro structural and mechanical properties. It was observed that joint produced at 1000 rpm gain a maximum tensile strength which was 74% of the base material strength.

Yadav and Bhatwadekar [64] conducted experiment on AA6101 Aluminium and pure Copper plates of 5mm thickness in butt joint pattern. Welding was done at speed of 700 rpm and at 11mm/min tool traverse speed and tool with cylindrical configuration. Welded joint shows onion ring structure in stir zone. They found that AA6101 and copper joint was brittle in character, more downhill force, higher welding speed and rotational speed produces strong butt joint.

S. Jambulingam [65] selected material were AA7075 and AA3014 and joined by friction stir welding, 9 experiments were conducted at different speed, feed, and axial force. Taguchi scheme was used for design of experiments. He found optimum parameters were 1200 rpm speed, 10 mm/min feed with cylindrical tool profile. based on L9 orthogonal array were used. Hardness measure in Vickers hardness tester and tensile stress and yield stress are measured. Optimization analysis was completed using MINITAB. Dissimilar metal joining process using friction stir welding is tricky to achieve because of different co-efficient of heat and the base metal chemical composition. Welding parameters like rotational speed, traverse speed, axial force and tilt angle which plays a extremely significant role for increasing the weld quality.

Jawdat A. and Al-Jarrah [67] Worked for optimization of FSW Parameters for Joining Aluminum Alloys Using RSM. He used aluminum alloy sheets with thicknesses of 4, 5, 6, 7 and 8 mm were Butt jointed. High carbon steel used as tool material with flat cylindrical shoulder diameters of 18, 21, 24, 27 and 30 mm. rotational speed range used were 400, 700, 1000, 13000 and 1600 rpm. And welding speed range used 0.5, 1.0, 1.5, 2.0 and 2.5 mm/sec. it was found that a general result for a plate thickness of 6 mm, the most excellent arrangement to have maximum yield strength was 1000 rpm rotational speed with 1.5 mm/sec welding speed and a shoulder diameter of 24 mm. This experiment results defect free joints. Although, the superiority of welded joints depends on controlling, the rotation speed with welding speed to fill up the cavity behind the pin when stirring forward.

Dawes, et al [68] described the tool design and development approaches used at TWI and outlined some of the present tool designs under investigation; they analyzed the use of scroll shoulder for improving the quality of the joint and discussed several advantages and disadvantages linked with the use of shoulder features.

Loureiro, et al [69] also experimented with different shoulder geometry and observed that the scrolled shoulder is additional effective with less grain size and more hardness when compared to the weld with flat/concave shoulder tools.

Donatus et al. [70] studied the flow patterns in dissimilar friction stir welds of AA5083-O and AA6082-T6 alloys. It was observed that material flows more from the advancing side into the retreating side. The optimum grains were present close to the tool edge in the retreating side. The volume fraction of recrystallized grains grows into the deeper portion of the nugget from the stream arm region. Lowest hardness was present at nugget zone and the heat affected zone of the AA6082-T6 alloy side. Material pull from the RS to the AS is highest in the transition region between the tool shoulder domain and the tool pin domain. Materials tend to extrude out of the weld zone in the thermo mechanically affected zone of the retreating side itself, and it is caused by action of the tool shoulder and the tool pin. Combination of materials frequently occurs in the top surface in the tool shoulder domain, the nugget stem and in the nugget. The slower traverse welding speed gives a improved mixture of materials in the weld zones compared with the increased traverse welding speed.

J. C. Verduzco Juárez et.al., [71] This work deals with the effect of a new "bolt-head" pin profile on the friction stir welding performance of the aluminum alloy 6061-T6, compared to traditional pin profiles. Friction stir welding parameters such as the tool rotation speed and the welding speed were investigated together with the different pin profiles; the results show that the new "bolt-head" pin profile leads to superior mechanical properties of welded specimens. The pin profiles used in this work were the straight square (SS), straight hexagon (SH), taper cylindrical (TC), and the straight hexagon "bolt-head" (SHBH). It was found that the last pin profile improves the material flow behavior and the uniform distribution of plastic deformation and reduces the configuration of macroscopic defects on the welded zone. Mechanical tensile tests on welded specimens were performed to determine the tensile strength: the specimens welded with the SHBH pin profile have shown the uppermost mechanical properties. An approach was

presented for material flow on this aluminum alloy using the SHBH pin profile, which was related to the improvement on the resulting mechanical properties.

S. **Emamian et.al.** [72] In this study, the effects of different pin profiles with different rotational and traversing speed were elevated in order to obtain the optimum pin profile using heat generation and tensile strength. Three different rotational speed and welding speeds were applied with threaded cylindrical, conical, stepped conical and square pin profiles. Thermocouples K type has been embedded in array to trace the temperature during the welding at the advancing and the retreating side. The results of experimental process and design of experiments are correlated well. The better joint produced with threaded cylindrical tool pin profile with rotational speed of 1600rpm and welding speed of

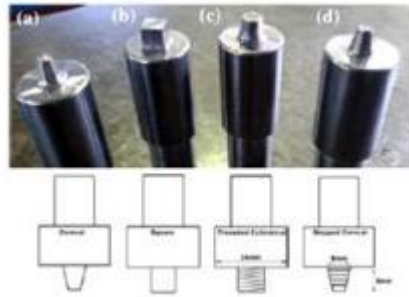
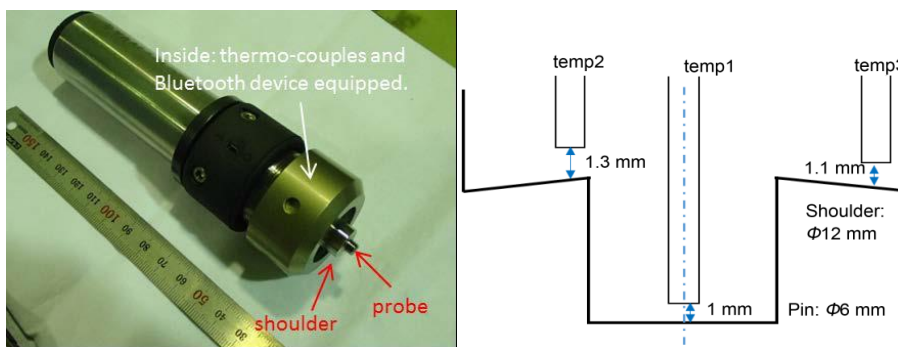

Fig. 4 Different pin profiles. a Conical b Square. c Threaded

40mm/min. In this study, by increasing the rotational speed was increase temperature. On the other hand, by increasing the welding speed, temperature comes down.

Takashi Nakamura et.al., [73] In this study, a thermo mechanically coupled process model was developed to investigate FSW phenomena inside a tool and workpiece. As a workpiece, 6061-T6 aluminum alloy was employed. The system of FSW process model includes several thermal boundaries. Among heat flows through these boundaries, heat transfers into the peripheral of the system become more responsive to tool and workpiece temperatures than heat transfers within the system. This paper particularly focused on a heat transfer coefficient at a workpiece bottom, and optimized it through experiments and finite element method (FEM) analyses. The tool temperatures during FSW were calculated with a special tooling system with imbedded thermocouples within a tool. Then, the accuracy of developed FEM model was validated with them. Finally, the temperatures and stress distribution around workpiece/tool interfaces were investigated with the developed model. Analysis results with the developed model show that temperature inside the probe was around 440°C at the center of the top surface and 400°C at the probe root. Calculated temperature distribution proved that the measured temperature with the thermocouple at the probe tip was exactly the same as the



surface temperature. Thermocouples were inserted in the pre-holed work-pieces. These positions were decided based on experimental trials. The welded joints were made such that they are free of internal defects. Temperature histories were calculated using thermocouples during FSW at specified locations on the work-piece in the welding direction. Experimental results show that by increasing the plunge depth, tool rotation speed, the maximum temperature was increased, whereas it was contrary for welding speed.

Axel Fehrenbacher et.al., [74] In this study, a real-time wireless temperature measurement system has been created and successfully implemented for closed-loop control of tool shoulder-workpiece interface temperature. The system consist two thermocouples in through holes and measures the shoulder and pin interface temperatures with an angular resolution as small as 10°. Both temperatures correlate with weld quality (mechanical testing and weld cross sections), e.g., all welds in 4.76-mm-thick 6061-T6 with an average shoulder interface temperature below 520 °C and an average pin border temperature below 460 °C fail in the weld zone as an alternative of the heat-affected zone, have improper tensile strengths and in some cases voids.

Dr. Lingaraju Dumlala et.al., [75] In this survey, AA6061- T6, AA5083 of each 6 mm thickness plates were fabricated Butt joint by friction stir welding with different process parameters. The process parameters of spindle speeds are 800, 1000 and 1200 rpm. Welding speeds were 05, 10, 20 and 30 mm/min. A taper threaded H13 steel tool was used. Simulation of friction stir welding processes was carried out in Deform 3D software, in order to understand the changes in the welding process under the different process parameters. In order to cover with the obtaining results they are validate by using DEFORM-3D simulation software

Narayanasamy Babu et.al.[76],The objective of this work is to forecast the temperature distribution in butt welding of AA 5059 aluminium alloy of 4 mm thick plates during friction stir welding. Numerical simulations were developed as a three dimensional, non-linear finite element model using COMSOL multi-physics to predict the complete thermal history of the welded specimens. Experimental work has also been carried out to explore the thermal history of a workpiece. The temperatures predicted numerically are verified to the experimental values in order to assess the joint performance and the weld zone characteristics. These results specify that the values are in good agreement with each other.

Ahmed O et.al.,[77] this study presents friction stir welding of aluminium and copper using experimental work and theoretical modelling. The 5083-H116 aluminium alloy and pure copper were effectively friction-stir-welded by offsetting the pin to the aluminium side and controlling the FSW parameters. The process temperatures are predicted logically using the inverse heat transfer method and correlated with experimental measurements. The temperature distribution in the immediate surroundings of the weld zone is investigated jointly with the microstructures and mechanical properties of the joint. This was supported by a finite element analysis using COMSOL Multiphysics. In this study, two rotational speeds were used and a range of offsets was applied to the pin. The microstructure analysis of the joints was undertaken. It was identified that it was practically difficult (almost impractical) to obtain a high-quality Al-Cu direct joint without offsetting the pin in the softer material (aluminium). It was recognized that it was practically difficult (almost impossible) to obtain a high-quality Al-Cu direct joint without offsetting the pin in the softer material (aluminium). It was identified experimentally and theoretically that the heat dissipation in the Cu side was higher than in the Al alloy side. This was supported by a good concurrence between the experiment and the modelling

Mostafa Akbar et.al .,[78] In this study, the effect of the process parameters on the axial and longitudinal forces and the temperature history of the process were investigated. The tool forces were investigated experimentally using an especially designed load measuring system. The pin shape, rotational speed and traverse speed were the parameters taken into consideration. In summary, the subsequent conclusions were reached. Specimens of the square, triangle and cylindrical pin shape had the highest temperature, respectively

S. Amini et.al.,[79] In this paper, effect of pin position (relative to tool shoulder position) on welded joint in friction stir welding (FSW) of aluminum 5083-O was investigated. To do this study, a FSW process was prepared by designing and fabricating tool and workpiece fixture and installing them on a milling machine. Then, some experiments were performed using the tool with a pin coaxial with the axis of tool shoulder. Hence, the tool enters edges of joint location and moves along joint line. Achieved results showed heat generation, severe plastic deformation, and material displacement in joint location which led to completeness of joint's edges. It was also found that the tool temperature for tools with half pin and arched pin had a significant increase with the increase of

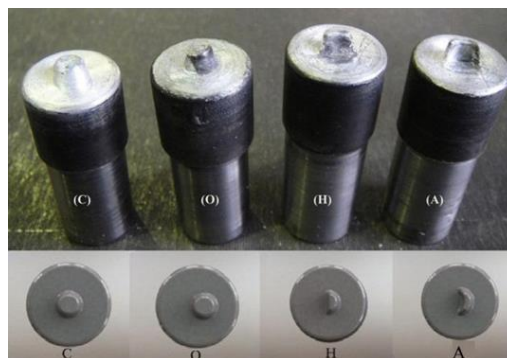

Fig 6 Different tool pins and their positions

rotational speed . C concentric cone-shaped pin with tool shoulder, O offset cone-shaped pin that has offset relative to the tool shoulder, H tool with half cone-shaped pin, A tool with cone shaped arched pin

Mohamadreza Nourani et al. [80] worked on Taguchi Optimization of Process Parameters in Friction Stir Welding of 6061 Aluminum Alloy: A Review and Case Study. His study intended to present computationally efficient method for optimizing the process parameters of friction stir welding of 6061 aluminum alloy. ANOVA analysis on the L9 orthogonal array with three factors is done and results shows that among the parameters considered (*i.e.*, the tool rotational speed, transverse speed, and the axial force), the most important parameter on the weld quality is the rotational

speed, followed by the axial force and transverse speed. Results indicate the tool rotational speed was the highest significance, followed by the normal force and the welding speed. Variation of the rotational speed of the tool leads to 51% contribution on the HAZ distance to the weld line. The minimized peak temperature of 458.90°C in the case study indicated a 91°C temperature reduction from the nominal (initial) value of 550°C. The ANOVA method of the Taguchi L9 design and the full factorial analysis yielded similar parameter contributions.

D.Devaiah et.al., [81] Taguchi method was applied to find the most significant control factors which will yield higher tensile strength of the joints of friction stir welded dissimilar AA5083 and AA6061 aluminum alloy. In order to optimize the process parameters such as tool rotational speed, weld travel speed and tool tilt angle on tensile strength of friction stir welded dissimilar AA5083 and AA6061 aluminium alloy, Taguchi Design of Experiment (DOE) and optimization method was used. The percentage contribution of FSW process parameters was evaluated. It was observed that the tool Rotational speed has 67.2% contribution, tool tilt angle 15% and traverse speed has 13.5 % contribution to Ultimate tensile, strength of welded joints. The optimum value of process parameters like rotational speed, traverse speed and tool tilt angle were determined to be 1120 r/min, 70 mm/min and 20 degrees respectively.

CONCLUSIONS:

From the above literature study the following points are observed: 1) It is to be observed that the rotational speed affects the peak temperature, defects formation and sizes, and the mechanical properties of friction stir welded joints. 2) As the rotation speed increased above 5000 rpm, the reduction in peak temperature can be observed due to the decrease in shear stress of the plastic material around the tool. 3) Peak temperature decreases with decreasing the tool rotational speed but vice versa with welding speed. 4) It is to be observed that threaded and square pin profile were observed as superior in terms of producing sound quality joints. 5) It is observed that the temperature on advancing side is on higher side as compared to retreating side. 6) The maximum value of the temperature obtained near the weld increases as the tool holding time and rotational speed were increased. 7) It was shown that with increasing the shoulder diameter, the tensile strength increases. 8) There is a positive relationship between the axial load and tensile strength. If axial load increases tensile strength also increases. Also as dwell time increases joint strength increases up to certain limit and then starts declining. 9) It is to be observed that the Experimental and numerical results from the Ansys, Hyperworks software's were correlated with good agreement and also correlated with Design of Experiments by using L type arrays.

REFERENCES:

1. Senkara, J.; Zhang, H. Cracking in spot welding aluminum Alloy AA5754. *Weld. J.* **2000**, 79, 194– 201.
2. Miles, M.P.; Nelson, T.W.; Decker, B.J. Formability and strength of friction-stir-welded aluminum sheets. *Metall. Mater. Trans. A* **2004**, 35, 3461– 3468. [CrossRef].
3. Kulekci, M.; Ik, A.S.; Kaluc, E. Effects of tool rotation and pin diameter on fatigue properties of friction stir welded lap joints. *Int. J. Adv. Manuf. Technol.* **2008**, 36, 877–882. [CrossRef].
4. M Song, R. Kovacevic, Thermal modeling of friction stir welding in a moving coordinate and its validation, *International Journal of Machine Tool and Manufacturing* 43 (6) (2003) 605–615.
5. Gan, W., Okamoto, K., Hirano, S., Chung, K., Kim, C., Wagoner, R.H., 2008. Properties of friction-stir welded aluminum alloys 6111 and 5083. *Journal of Engineering Materials and Technology, Transactions of the ASME* 130 (3), 031007-1– 031007-15.
6. Sivakumar, Vignesh Bose, D.Raguraman, D.Muruganandam, Review Paper on Friction Stir Welding of various Aluminium Alloys, *IOSR Journal of Mechanical and Civil Engineering (IOSR-JMCE)* e- ISSN: 2278-1684, p-ISSN : 2320– 334X PP 46-52
7. ATHARIFAR H, LIN D, KOVACEVIC R. Numerical and experimental investigations on the loads carried by the tool during friction stir welding [J]. *Journal of Materials Engineering and Performance*, 2009, 18(4): 339–350.
8. Schmidt, H., Hattel, J., 2005. A local model for thermo-mechanical conditions in friction stir welding. *Model. Simul. Mater. Sci. Eng.* 13, 77–93.
9. M. M. El-Sayed*, A. Y. Shash*, †, M. Abd Rabou*, Heat Transfer Simulation and Effect of Tool Pin Profile and Rotational Speed on Mechanical Properties of Friction Stir Welded AA5083-O, *Journal of Welding and Joining* 2017; 35(3): 35-43.
10. Tomotake Hirata a*, Taizo Oguri a, Hideki Hagino a, Tsutomu Tanaka, Influence of friction stir welding parameters on grain size and formability in 5083 aluminum alloy, *Materials Science and Engineering A* 456 (2007) 344–349.
11. C.M. Chen, R. Kovacevic, Finite element modeling of friction stir welding—thermal and thermomechanical analysis, *International Journal of Machine Tools & Manufacture* 43 (2003) 1319– 1326
12. G.J. Bendzszak, T.H. North, C.B. Smith, An experimentally validated 3D model for friction stir welding, in: *Proceedings of the Second International Symposium on 'Friction Stir Welding'*, TWI Ltd., Gothenburg, Sweden, 2000.
13. Leitao, C., Leal, R. M., Rodrigues, D. M., et al. Mechanical behaviour of similar and dissimilar AA5182-H111 and AA6016-T4 thin friction stir welds. *Mater. Des.*, 2009, Vol. 30, pp. 101–108
14. Palanivel, R., Mathews, P. K., Murugan, N., et al. Effect of tool rotational speed and pin profile on microstructure and tensile strength of dissimilar friction stir welded AA5083- H111 and AA6351-T6 aluminum alloys. *Mater Des.*, 2012, Vol. 40, pp. 7–16.

15. Peel, M. J., Steuwer, A., Withers, P. J., et al. Dissimilar friction stir welds in AA5083–AA6082. Part I: process parameter effects on thermal history and weld properties. *Metall Mater Trans A*, 2006, Vol. 37 A, pp. 2183–2193.
16. Leal, R. M., Leitao, C., Loureiro A, et al. Material flow in heterogeneous friction stir welding of thin aluminum sheets: effect of shoulder geometry. *Mat Sci Eng A*, 2008, Vol. 498, pp. 384–391.
17. P Satish Kumar, Ch S R Shastry, Aruri Devaraju, Influence of Tool Revolving on Mechanical Properties of Friction Stir Welded 5083 Aluminum alloy, *Materials Today: Proceedings 4 (2017) 330– 335*
18. E. Fereiduni, M. Movahediand A.H. Kokabi, “Aluminum/steel joints made by an alternative friction stir spot welding process”, *Journal of Materials Processing Technology 224*, 2015, pp. 1– 10.
19. Raza Moshwan, FarazilaYusof, M. A. Hassan and S. M. Rahmat, “Effect of tool rotational speed on force generation, microstructure and mechanical properties of friction stir welded Al–Mg–Cr–Mn (AA 5052-O) alloy”, *Materials and Design 66*, 2015, pp. 118–128.